

SONDÈ

TAVOLO / TABLE

TAVOLO "SONDÈ" ALLUNGABILE
STRUTTURA METALLO VERNICIATO,
PIANO SP. 2 IMPIALLACCIATO

"SONDÈ" EXTENDIBLE TABLE
PAINTED METAL FRAME,
2 TH. VENEERED TOP

140,5 X 90 H 76 N.2 PROLUNGHE DA 50
140,5 X 90 H 76 N.2 EXTENSIONS CM 50

160,5 X 90 H 76 N.2 PROLUNGHE DA 50
160,5 X 90 H 76 N.2 EXTENSIONS CM 50

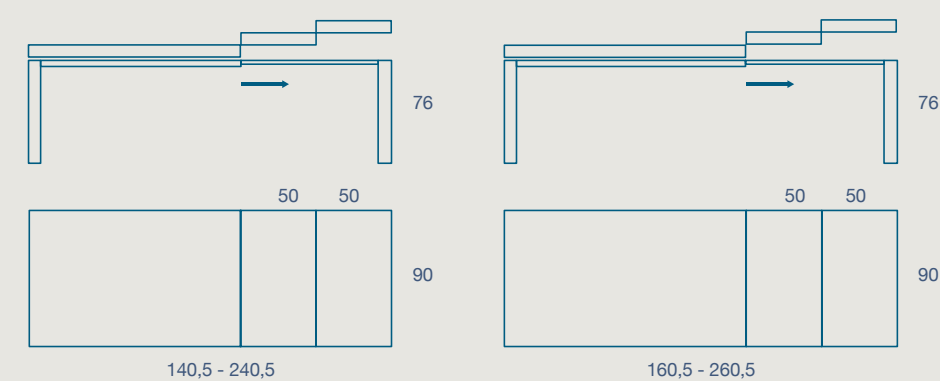

METALLO



PAPERSTONE



IMPIALLACCIATO



CERAMICO

TAVOLO "SONDÈ" ALLUNGABILE
STRUTTURA METALLO VERNICIATO,
PIANO SP. 2 PAPERSTONE E PROLUNGHE IN PAPERSTONE
PIANO SP.1,2 CERAMICO CON SUPPORTO IN VETRO E PROLUNGHE IN MDF LACCATE COME STRUTTURA

"SONDÈ" EXTENDIBLE TABLE
PAINTED METAL FRAME,
2 TH. PAPERSTONE TOP AND PAPERSTONE EXTENSIONS
12 TH. CERAMIC TOP WITH GLASS SUPPORT AND MDF EXTENSIONS LACQUERED AS THE FRAME

140,5 X 90 H 75 N.2 PROLUNGHE DA 50
140,5 X 90 H 75 N.2 EXTENSIONS CM 50

160,5 X 90 H 75 N.2 PROLUNGHE DA 50
160,5 X 90 H 75 N.2 EXTENSIONS CM 50

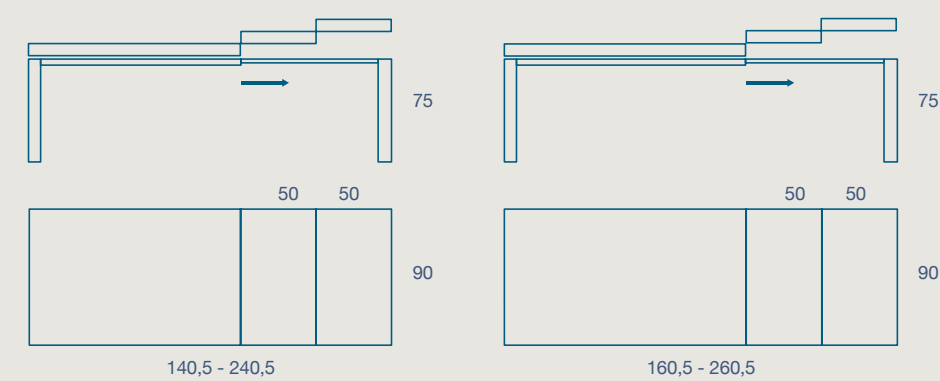

SEDIA ONIR
ONIR CHAIR



METALLO



PAPERSTONE



IMPIALLACCIATO



CERAMICO



FINITURE STRUTTURA METALLO VERNICIATO OPACO

MATT PAINTED METAL STRUCTURE FINISHES



bianco assoluto (opz. 740)
absolute white



beige arizona (opz.0748)
arizona beige



fumo (opz. 9531)
smoke



grigio piombo (opz.9537)
lead grey

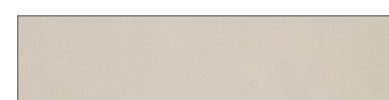

lino (opz. W770)
linen

FINITURE PIANO PAPERSTONE

PAPERSTONE TOP FINISH



sand bordo millerighe (opz. SAN)
sand ribbed edge



pewter bordo millerighe (opz.PEW)
pewter ribbed edge



charcoal (opz. CHA)
charcoal



slate (opz. SLA)
slate

CODICE / CODE

DESCRIZIONE / DESCRIPTION

08OD14P

Paperstone 140,5x90 allungabile 240,5 H75 / Paperstone 140,5x90 allungabile 240,5 H75

08OD16P

Paperstone 160,5x90 allungabile 260,5 H75 / Paperstone 160,5x90 allungabile 260,5 H75

FINITURE PIANO IMPIALLACCIATO FRASSINO TINTO ROVERE

OAK STAINED ASH VENEERED TOP FINISHES



CLOVER

[ESCLUSO NOCE CANALETTO OPZ. 1324 / CANALETTO WALNUT OPT.1324 EXCLUDED](#)

LUNA

[ESCLUSO NOCE CANALETTO OPZ. 1331 / CANALETTO WALNUT OPT.1331 EXCLUDED](#)

FINITURE PIANO IMPIALLACCIATO NOCE

WALNUT VENEERED TOP FINISHES



tinto noce canaletto (opz. 1324)
stained canaletto walnut



tinto noce canaletto (opz. 1331)
stained canaletto walnut

CODICE / CODE

DESCRIZIONE / DESCRIPTION

08OD14W

Impiallacciato 140,5x90 allungabile 240,5 H76 / Veneered 140,5x90 allungabile 240,5 H76

08OD16W

Impiallacciato160,5x90 allungabile 260,5 H76 / Veneered 160,5x90 allungabile 260,5 H76

FINITURE PIANO CERAMICO

CERAMIC TOP FINISHES

NON DISPONIBILE NELLE FIN. CAESAR

NOT AVAILABLE IN THE CAESAR FINISHES

CODICE / CODE

DESCRIZIONE / DESCRIPTION

08OD14C

Ceramico 140,5x90 allungabile 240,5 H75 / Ceramic 140,5x90 allungabile 240,5 H75

08OD16C

Ceramico 160,5x90 allungabile 260,5 H75 / Ceramic 160,5x90 allungabile 260,5 H75

FINITURE IMPIALLACCIATO

VENEERED FINISHES

FINITURE MODELLI LUBE / LUBE KITCHENS FINISHES



CLOVER
CREATIVA
LUNA
OLTRE
PROVENZA

FINITURE MODELLI CREO / CREO KITCHENS FINISHES



AUREA
CONTEMPO



LUBE CLOVER

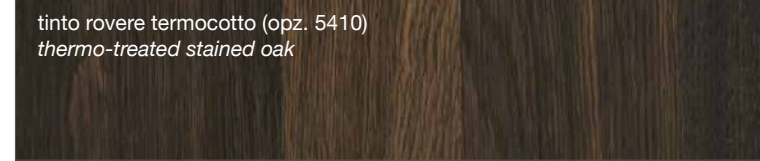
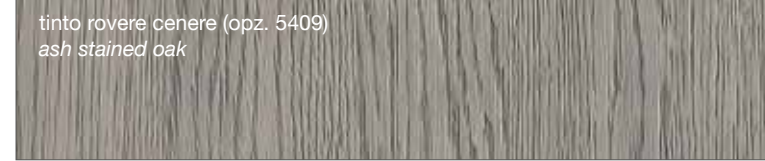
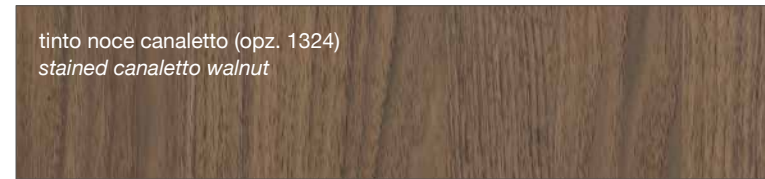

FINITURE LACCATE - LACQUERED FINISHES

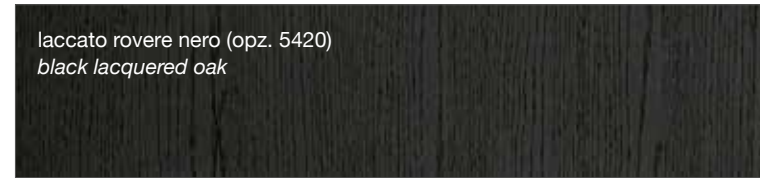
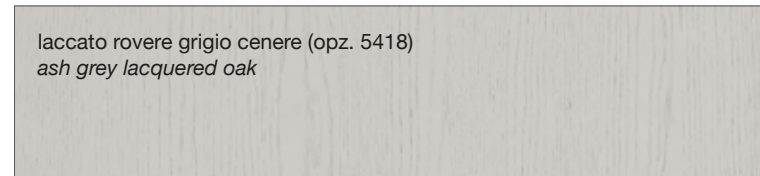
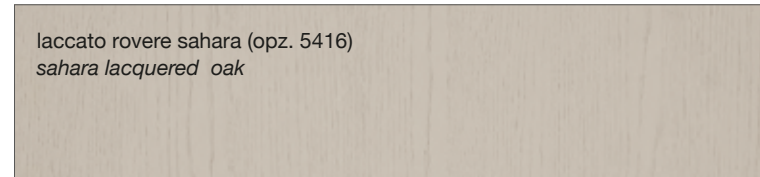
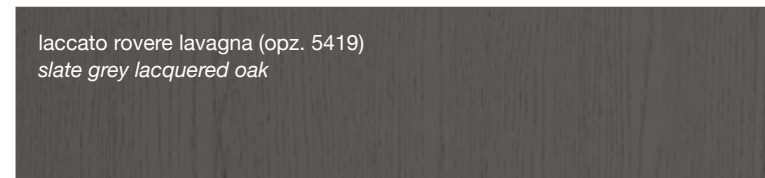
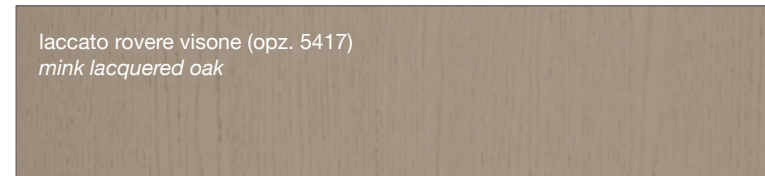
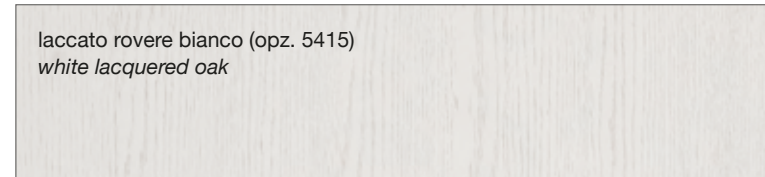

FINITURE TINTE - STAINED FINISHES

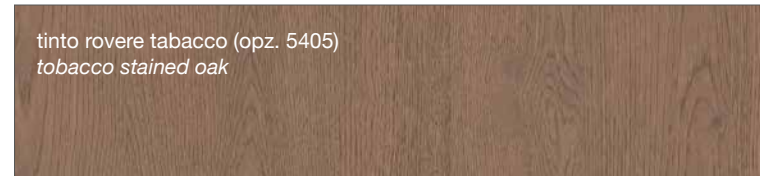
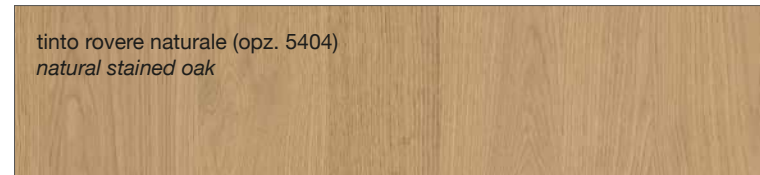
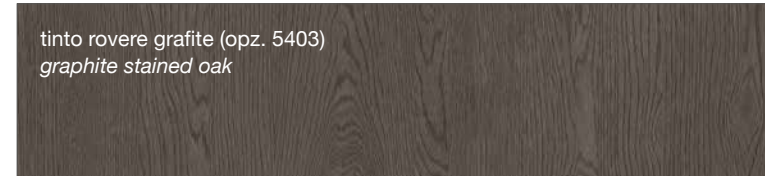
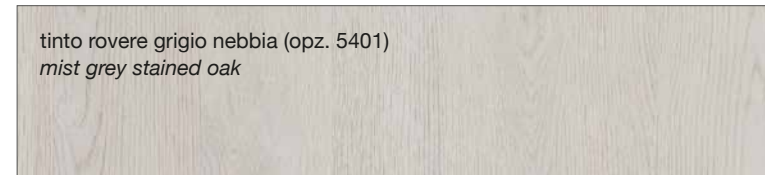

LUBE CREATIVA



LUBE LUNA

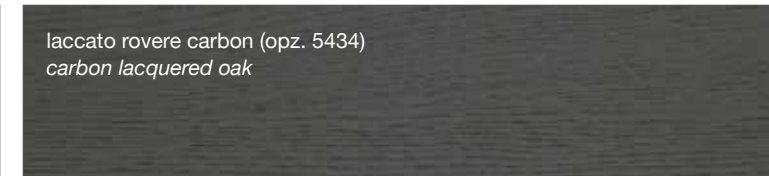
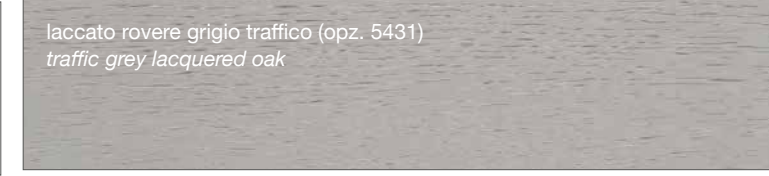
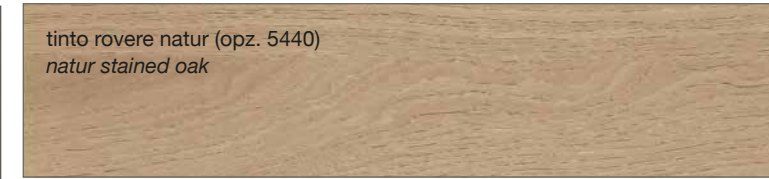
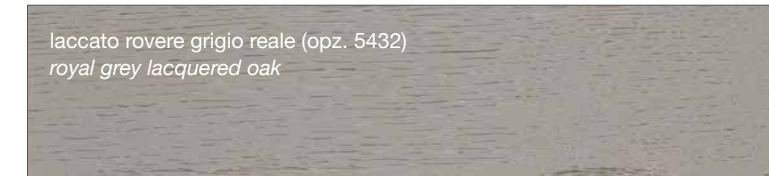
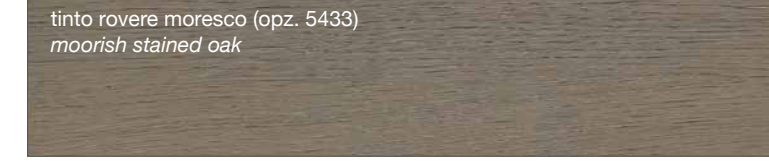
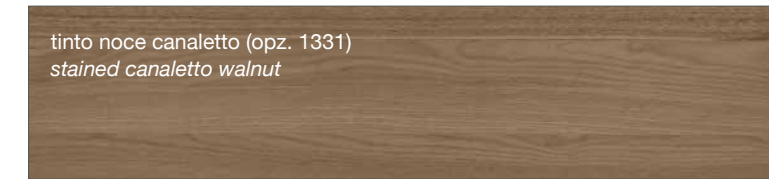

LUBE OLTRE

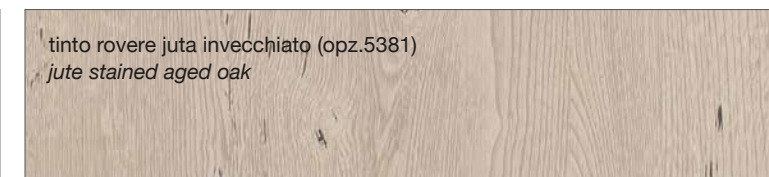
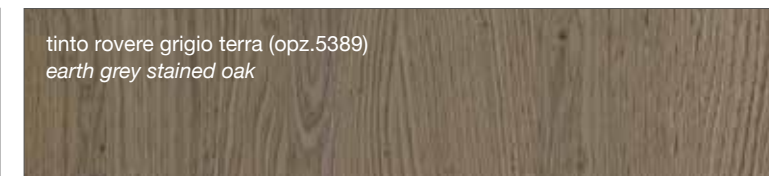
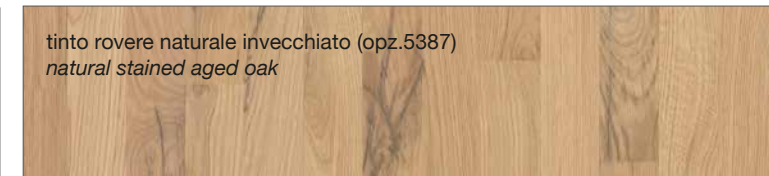
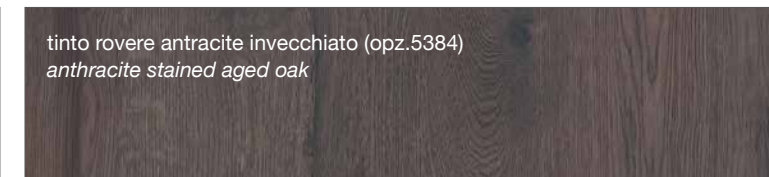
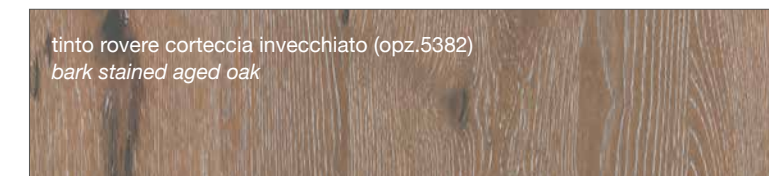
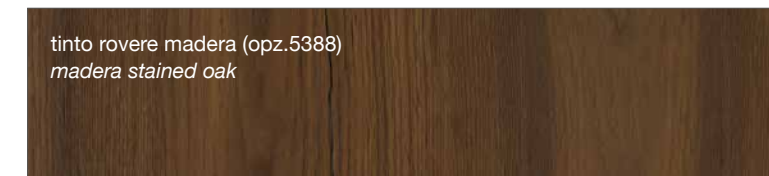
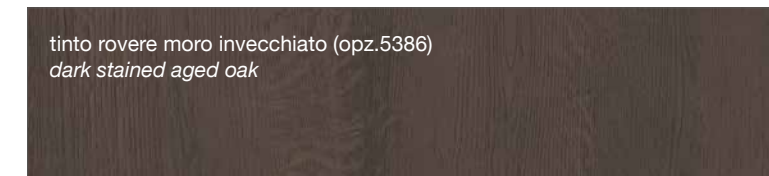
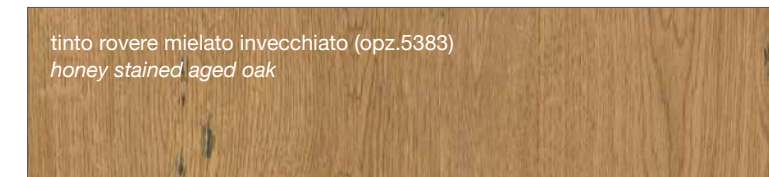

LUBE **PROVENZA**

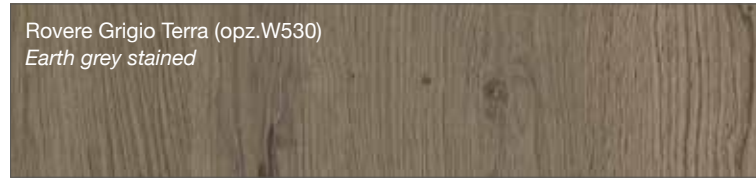

CREO **AUREA**

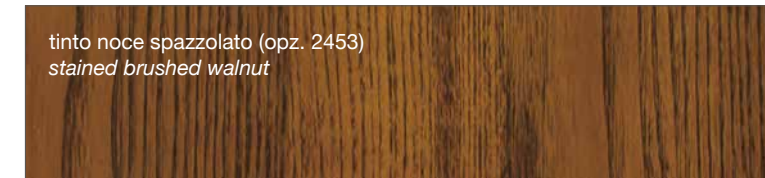
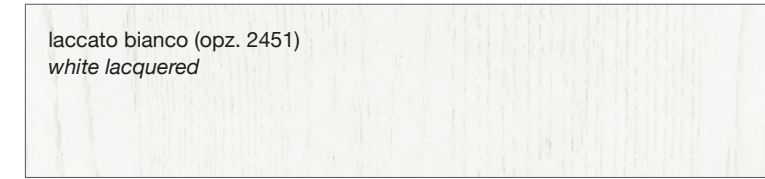

CREO **CONTEMPO**

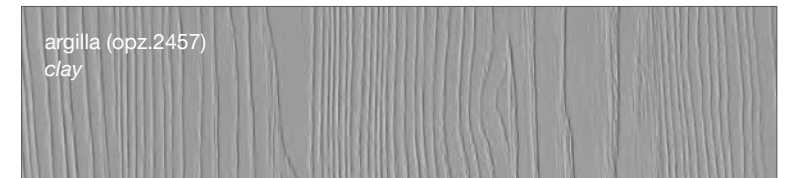

FINITURE MATERIALE CERAMICO

CERAMIC MATERIALS FINISHES

KERLITE

MUTINA

GRES INFINITY

GRES LAMINAM

GRES OLOS BY CAESAR



FINITURA KERLITE

KERLITE FINISHES

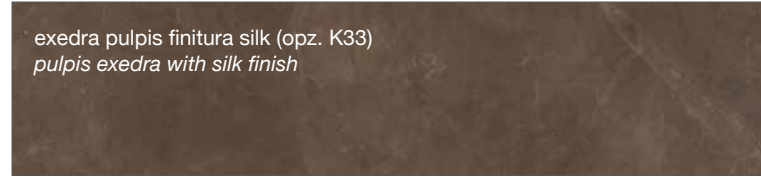

exedra pulpis finitura silk (opz. K33)
pulpis exedra with silk finish

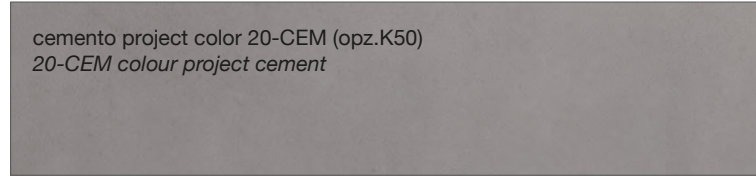

cemento project color 20-CEM (opz.K50)
20-CEM colour project cement



exedra calacatta finitura silk (opz. K31)
calacatta exedra with silk finish

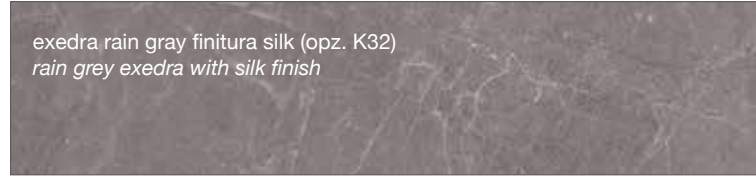

exedra rain gray finitura silk (opz. K32)
rain grey exedra with silk finish

FINITURA MUTINA

MUTINA FINISHES

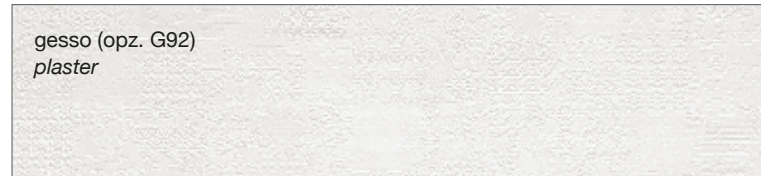

gesso (opz. G92)
plaster



avana (opz. G91)
havana



grafite (opz. G90)
graphite

FINITURA GRES INFINITY

GRES INFINITY FINISHES



concrete light (opz. ce01)
concrete light



terrazzo white (opz. ma01)
terrazzo white



pierre bleue (opz. se04)
pierre bleue



terrazzo grey (opz. ma03)
terrazzo grey



milan stone (opz. se03)
milan stone



terrazzo black (opz. ma04)
terrazzo black

FINITURA GRES LAMINAM

GRES LAMINAM FINISHES

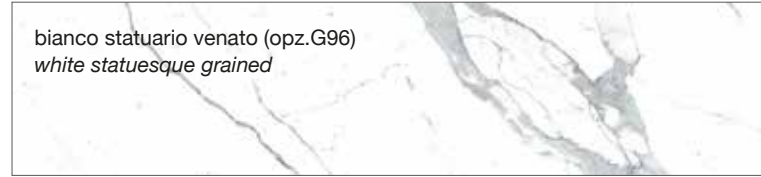

bianco statuario venato (opz.G96)
white statuesque grained



terra finitura fokos (opz.G71)
fokos finish earth



avorio finitura blend (opz.G40)
blend finish ivory

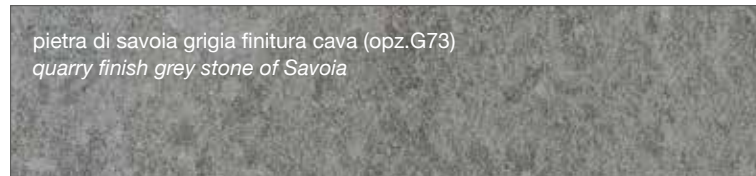

pietra di savoia grigia finitura cava (opz.G73)
quarry finish grey stone of Savoia

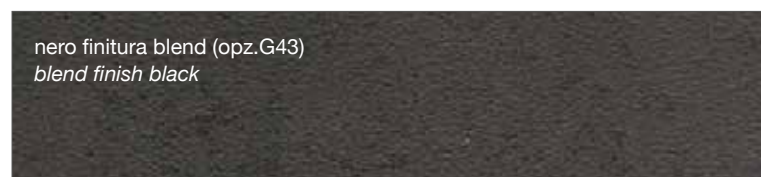

nero finitura blend (opz.G43)
blend finish black

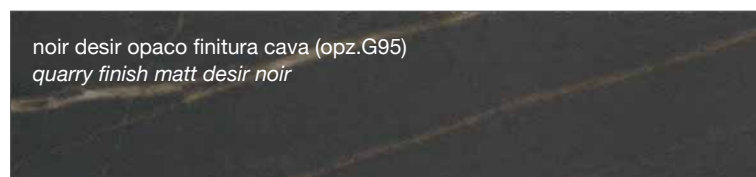

noir desir opaco finitura cava (opz.G95)
quarry finish matt desir noir

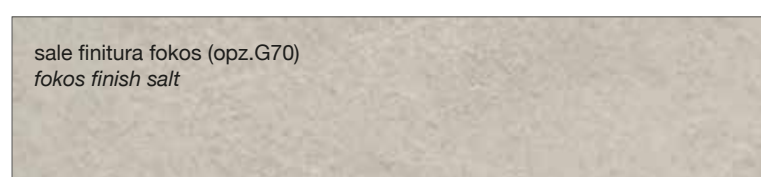

sale finitura fokos (opz.G70)
fokos finish salt

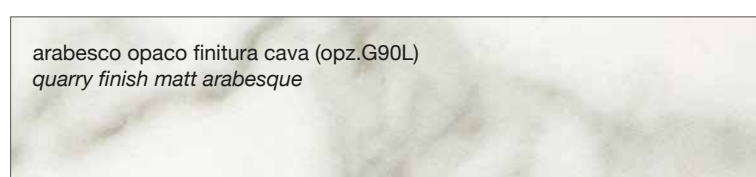

arabesco opaco finitura cava (opz.G90L)
quarry finish matt arabesque

FINITURA GRES OLOS BY CAESAR

GRES OLOS BY CAESAR FINISHES



portraits kirkby (opz. CA03)
portraits kirkby



relate reef (opz. CA06)
relate reef

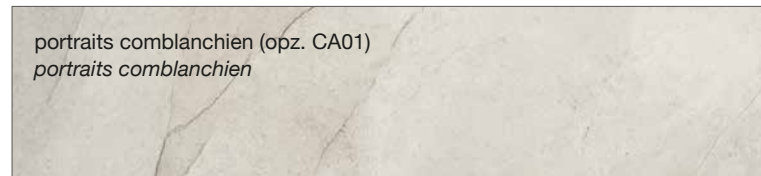

portraits comblanchien (opz. CA01)
portraits comblanchien



relate blaze (opz. CA05)
relate blaze



portraits mint (opz. CA04)
portraits mint



relate mine (opz. CA07)
relate mine



relate blizzard (opz. CA02)
relate blizzard