



METALLO



LAMINATO



FENIX



IMPIALLACCIATO

# PIN LAMINATO, FENIX E IMPIALLACCIATO

TAVOLO / TABLE

TAVOLO "PIN" ALLUNGABILE CON PROLUNGHE NELLA FINITURA DEL TAVOLO  
STRUTTURA E GAMBE A SPILLO METALLO VERNICIATO  
PIANO SP. 2,2 LAMINATO, FENIX E IMPIALLACCIATO

"PIN" EXTENDIBLE TABLE WITH EXTENSIONS IN THE SAME FINISH AS THE TABLE  
PAINTED METAL FRAME AND POINTED LEGS  
2.2 TH. LAMINATE, FENIX AND VENEERED TOP

130 X 90 H 78 N.2 PROLUNGHE DA 50  
130 X 90 H 78 N. 2 EXTENSIONS CM 50

160 X 90 H 78 N.2 PROLUNGHE DA 50  
160 X 90 H 78 N. 2 EXTENSIONS CM 50

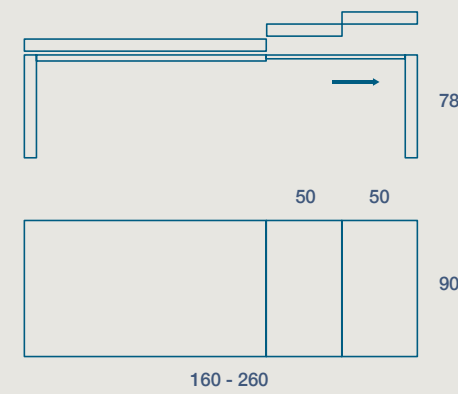
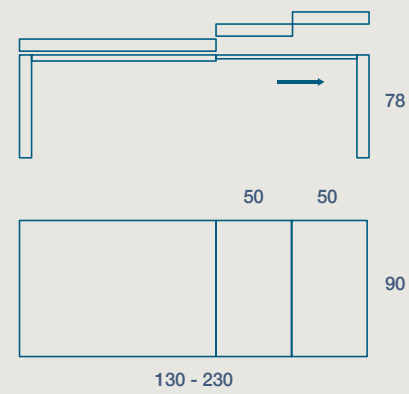

SEDIA BASAD  
BASAD CHAIR



METALLO



LAMINATO



FENIX



IMPIALLACCIATO



## FINITURE STRUTTURA

STRUCTURE FINISHES



ferro grezzo (opz. FG)  
rough iron

## FINITURE STRUTTURA METALLO VERNICIATO OPACO

MATT PAINTED METAL STRUCTURE FINISHES



bianco assoluto (opz. 740)  
absolute white

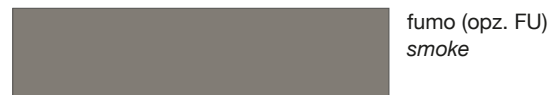

fumo (opz. FU)  
smoke



grigio piombo (opz.9537)  
lead grey



nero (opz.NE)  
black



castoro (opz. 8907)  
beaver



ruggine (opz. RU)  
rust



peltro (opz. PE)  
pewter



beige arizona (opz.0748)  
arizona beige



bistro (opz. 9535)  
bistro



argilla (opz. 9503)  
clay grey

## FINITURE PIANO LAMINATO

LAMINATE TOP FINISHES

FINITURA OPACA MALTA  
MATTE MORTAR FINISH

FINITURA OPACA CANSIGLIO  
MATTE CANSIGLIO FINISH

FINITURA OPACA SINCRO PORO EFFETTO LEGNO  
WOOD EFFECT SYNCHRO PORE MATT FINISH

FINITURA OPACA OSSIDATA 'T'  
MATTE OXIDIZED 'T' FINISH

FINITURA OPACA URBAN  
MATTE URBAN FINISH

## FINITURE PIANO FENIX

FENIX TOP FINISHES

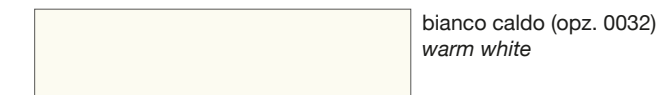

bianco caldo (opz. 0032)  
warm white



fumo (opz. 0718)  
smoke



castoro (opz. 0717)  
beaver



nero (opz. 0720)  
black



grigio bromo (opz. 0724)  
bromine grey



bronzo doha (opz. 2629)  
doha bronze

## FINITURE PIANO IMPIALLACCIATO

VENEERED TOP FINISHES



CODICE / CODE	DESCRIZIONE / DESCRIPTION
08PI13L	Laminato/Fenix 130 x 90 Allungabile 230 H 78 / Laminate/Fenix 130x90 Extendable 230 H 78
08PI16L	Laminato/Fenix 160 x 90 Allungabile 260 H 78 / Laminate/Fenix 160x90 Extendable 260 H 78

CODICE / CODE	DESCRIZIONE / DESCRIPTION
08PI13W	Impiallacciato 130 x 90 Allungabile 230 H 78 / Veneered 130 x 90 Extendable 230 H 78
08PI16W	Impiallacciato 160 x 90 Allungabile 260 H 78 / Veneered 160 x 90 Extendable 260 H 78



# FINITURE LAMINATO FENIX E MELAMINICO

LAMINATE, FENIX AND MELAMINE FINISHES

## FINITURE LAMINATO

LAMINATE FINISHES

---



IMMAGINA

NOEMI

PLANKY

VELVET

OSSIDATA "T"

LUNA

WRAKY

URBAN

TOUCH

DECORATIVO UTILIZZATO NEI TOP STRATIFICATO HPL

DECORATION USED IN THE LAYERED HPL TOP

KER

SMART

## FINITURE FENIX

FENIX FINISHES

---

## FINITURE MELAMINICO

MELAMINE FINISHES

---



MYA

KYRA VINTAGE





# FINITURE LAMINATO

LAMINATE FINISHES

**LUBE** **IMMAGINA PLUS** (FINITURE COME ANTA)  
(DOOR FINISHES)

## FINITURA OSSIDATA "A"

OXIDIZED "A" FINISH

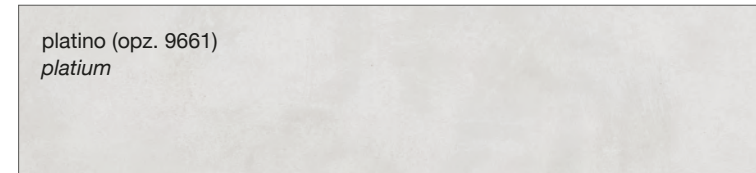

## FINITURA MATT

MATT FINISH

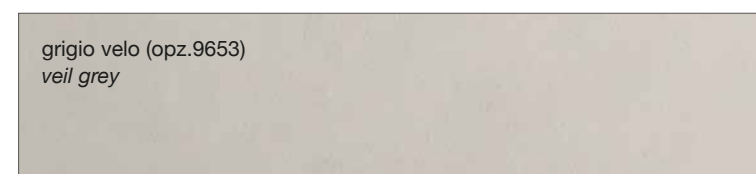
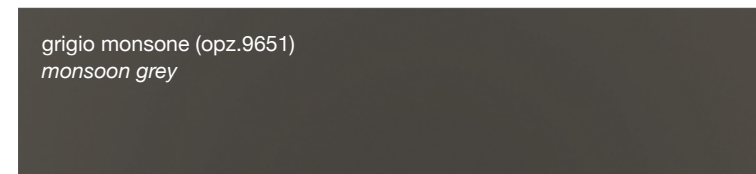

## FINITURA SPAZZOLATA

BRUSHED FINISH

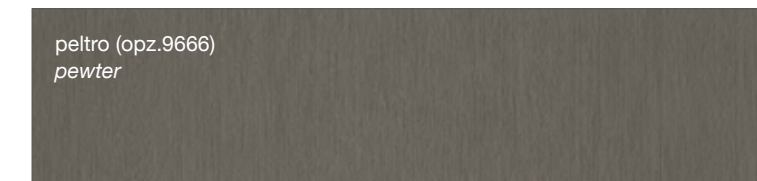

## FINITURA OPACA MALTA

MORTAR MATT FINISH

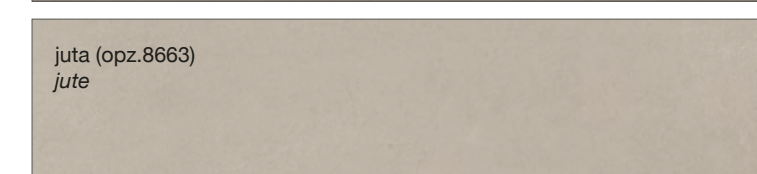
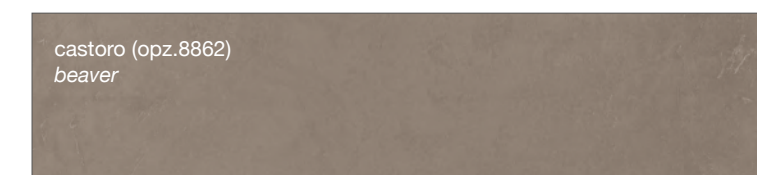
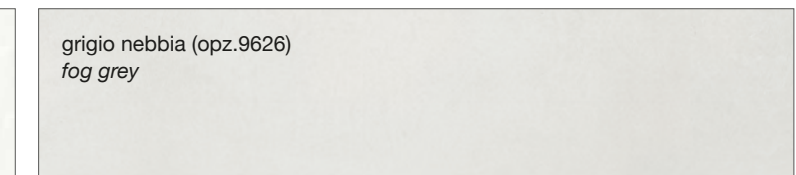
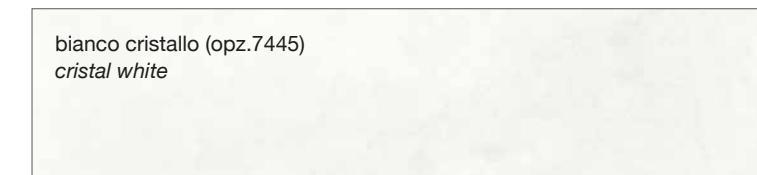

## FINITURA OPACA CANSIGLIO

CANSIGLIO MATT FINISH



## FINITURA MARMONIZZATA

MARbled FINISH

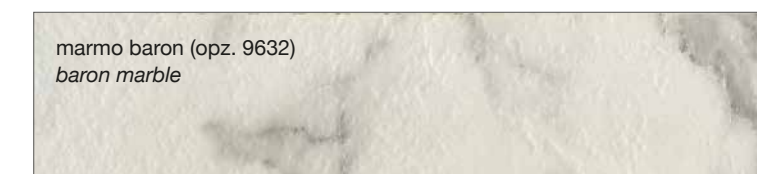

## FINITURA OPACA MATERICA

TEXTURED MATT FINISH



### FINITURA OPACA SINCRO PORO EFFETTO LACCATO

SYNC PORE LACQUERED EFFECT MATT FINISH



### FINITURA OPACA SINCRO PORO EFFETTO LEGNO

SYNC PORE WOOD EFFECT MATT FINISH



### FINITURA OPACA PORO APERTO A REGISTRO

REGISTER OPEN-PORE FINISH



## NOEMI

(FINITURE COME ANTA)  
(DOOR FINISHES)

### FINITURA SETA

MATT COLOURS WITH SKIN FINISH



### FINITURA SINCRO PORO

MATT COLOURS WITH SYNC PORE FINISH

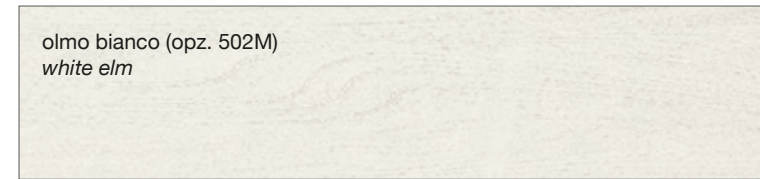







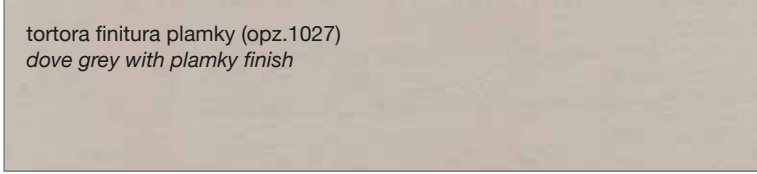
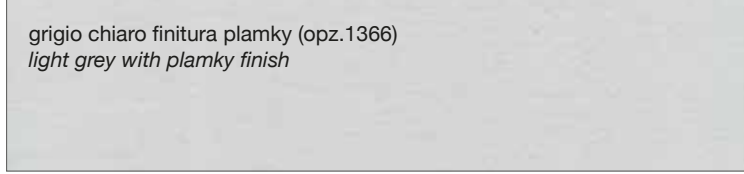
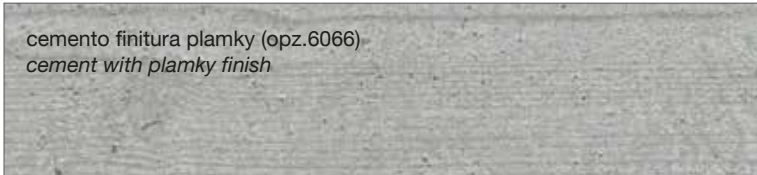

## FINITURE COME TOP LAMINATO

LAMINAM COUNTERTOP FINISHES

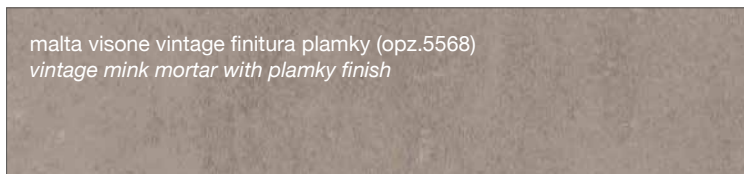
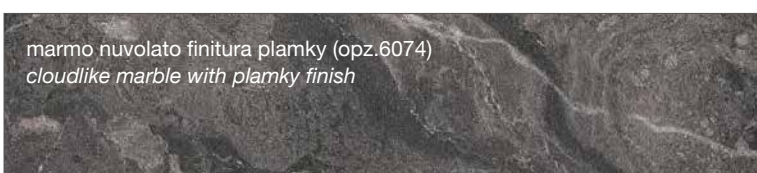
### FINITURA PLAMKY

PLAMKY FINISH

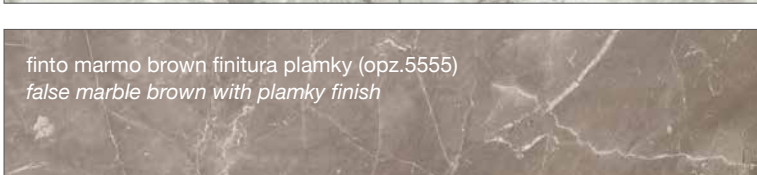
 <p>tortora finitura plamky (opz.1027) <i>dove grey with plamky finish</i></p>	 <p>grigio chiaro finitura plamky (opz.1366) <i>light grey with plamky finish</i></p>
 <p>cemento finitura plamky (opz.6066) <i>cement with plamky finish</i></p>	 <p>jaipur finitura plamky (opz.5564) <i>jaipur with plamky finish</i></p>
 <p>dover finitura plamky (opz.5567) <i>dover with plamky finish</i></p>	 <p>malta visone vintage finitura plamky (opz.5568) <i>vintage mink mortar with plamky finish</i></p>
 <p>marmo nuvolato finitura plamky (opz.6074) <i>cloudlike marble with plamky finish</i></p>	 <p>bardiglio grigio finitura plamky (opz.6075) <i>grey bardiglio with plamky finish</i></p>
 <p>acciottolato finitura plamky (opz.6078) <i>stoney with plamky finish</i></p>	 <p>grey finitura plamky (opz.9826) <i>grey with plamky finish</i></p>
 <p>finto marmo brown finitura plamky (opz.5555) <i>false marble brown with plamky finish</i></p>	

### FINITURA VELVET

VELVET FINISH

 <p>bianco finitura velvet (opz.800) <i>white with velvet finish</i></p>	 <p>acciaio invecchiato finitura velvet (opz.5550) <i>aged steel laminate with velvet finish</i></p>
---	--

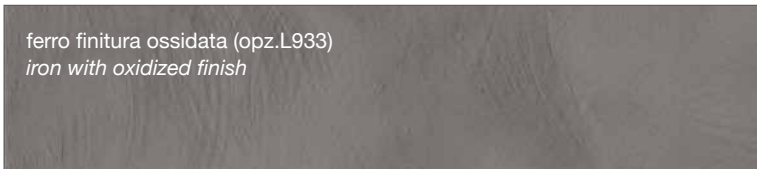

### FINITURA OSSIDATA "T"

OXIDIZED FINISH

 <p>ferro finitura ossidata (opz.L933) <i>iron with oxidized finish</i></p>	 <p>peltro finitura ossidata (opz.L934) <i>pewter with oxidized finish</i></p>
--	--

## FINITURA LUNA

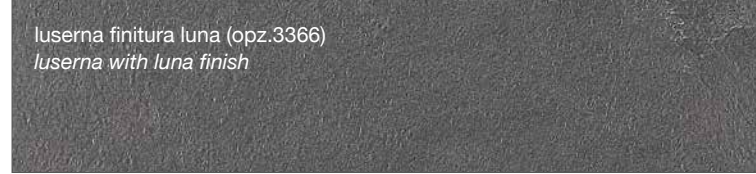
LUNA FINISH

 <p>luserna finitura luna (opz.3366) <i>luserna with luna finish</i></p>	 <p>oxun finitura luna (opz.3428) <i>oxun with luna finish</i></p>
 <p>bianco finitura luna (opz.001) <i>white luna finish</i></p>	

### FINITURA WRAKY

WRAKY FINISH

 <p>beton finitura wraky (opz.810) <i>beton with wraky finish</i></p>	 <p>esterel finitura wraky (opz.811) <i>esterel with wraky finish</i></p>
 <p>calce finitura wraky (opz.814) <i>whitewash with wraky finish</i></p>	 <p>pietra di nanto finitura wraky (opz.812) <i>nanto stone with wraky finish</i></p>

### FINITURA URBAN

URBAN FINISH

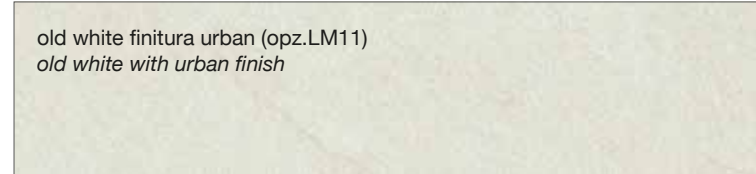
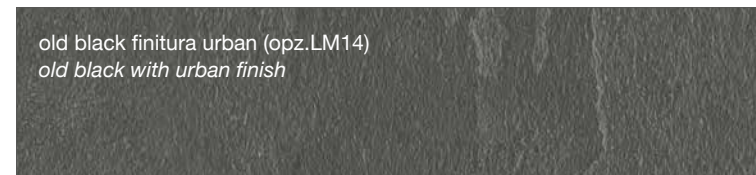
 <p>old white finitura urban (opz.LM11) <i>old white with urban finish</i></p>	 <p>old grey finitura urban (opz.LM12) <i>old grey with urban finish</i></p>
 <p>old dark finitura urban (opz.LM13) <i>old dark with urban finish</i></p>	 <p>old black finitura urban (opz.LM14) <i>old black with urban finish</i></p>
 <p>voyage silver finitura urban (opz.3413) <i>voyage silver with urban finish</i></p>	

### FINITURA TOUCH

TOUCH FINISH

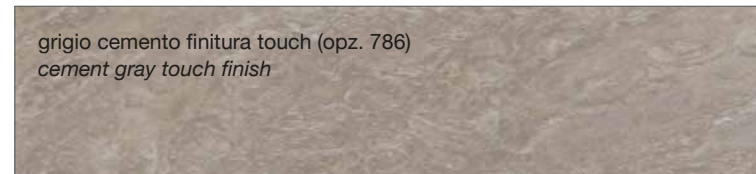
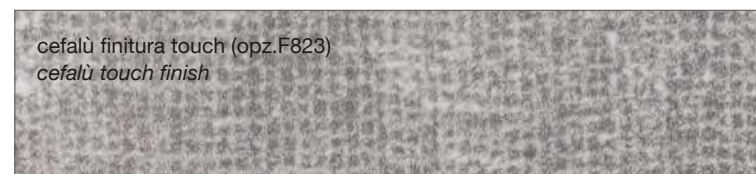
 <p>grigio cemento finitura touch (opz. 786) <i>cement gray touch finish</i></p>	 <p>casablanca finitura touch (opz.2444) <i>casablanca touch finish</i></p>
 <p>cefalù finitura touch (opz.F823) <i>cefalù touch finish</i></p>	



## FINITURA KER

KER FINISH



## FINITURA SMART

SMART FINISH



## FINITURA COME DECORATIVO UTILIZZATO NEI TOP STRATIFICATO HPL

FINISH AS DECORATION USED IN THE LAYERED HPL TOP

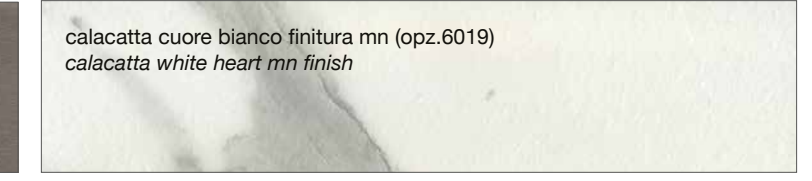
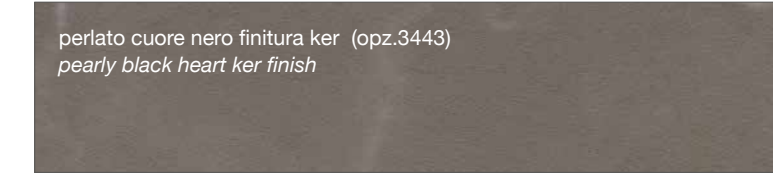
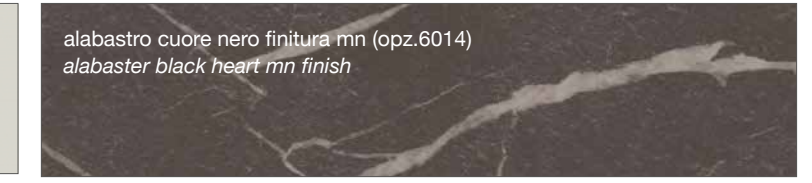
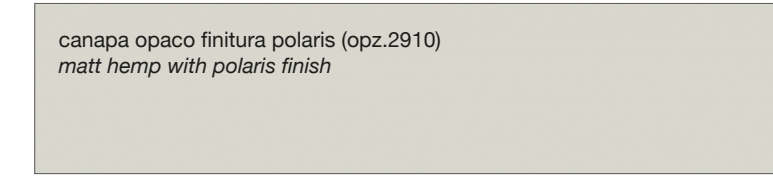
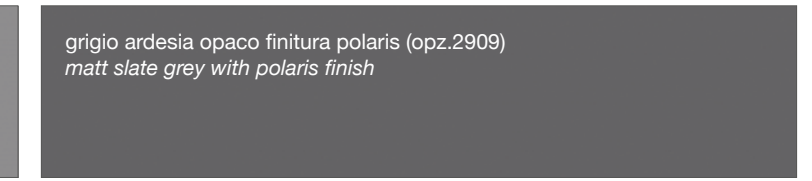
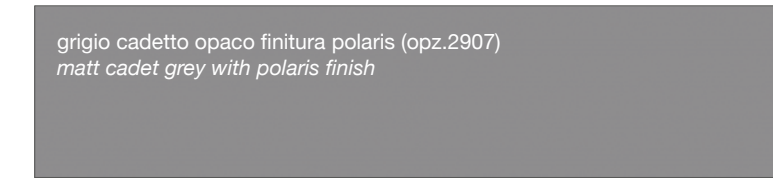
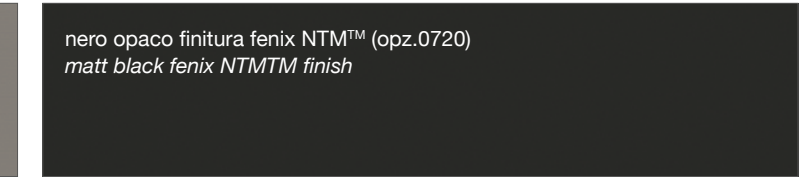
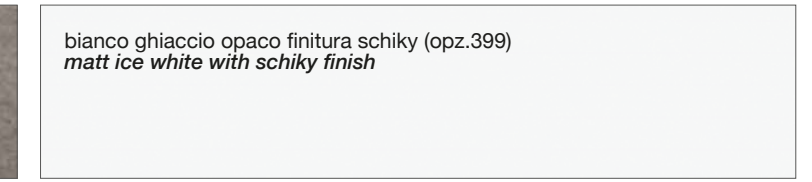
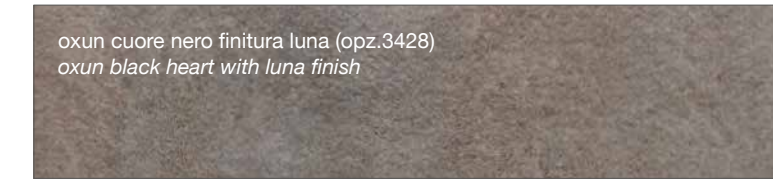
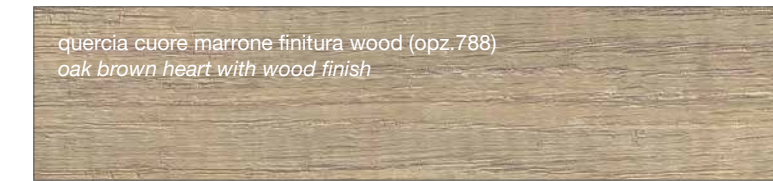
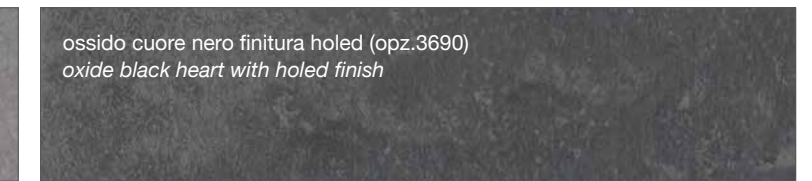
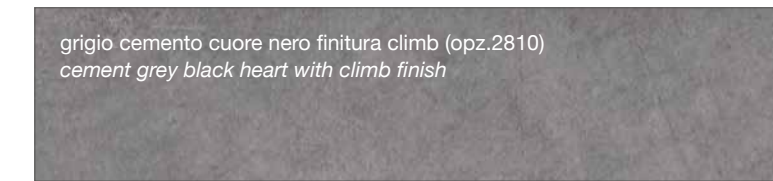
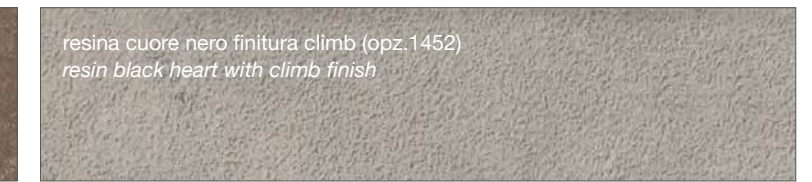
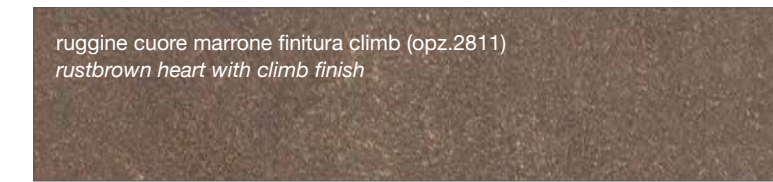

# FINITURE FENIX

FENIX FINISHES

## FINITURA FENIX NTM™

FENIX NTM™ FINISHES

<p>zinco doha (opz. 2628) <i>zinco doha</i></p>	<p>titanio doha (opz. 2638) <i>titanio doha</i></p>
<p>bronzo doha (opz. 2629) <i>doha bronze</i></p>	<p>piombo doha (opz. 2630) <i>piombo doha</i></p>
<p>bianco caldo (opz. 0032) <i>warm white</i></p>	<p>castoro (opz. 0717) <i>beaver</i></p>
<p>fumo (opz. 0718) <i>smoke</i></p>	<p>nero (opz. 0720) <i>black</i></p>
<p>grigio bromo (opz. 0724) <i>bromine grey</i></p>	<p>grigio antrim (opz. 0752) <i>antrim grey</i></p>
<p>cacao orinoco (opz. 0749) <i>orinoco cacao</i></p>	<p>beige arizona (opz. 0748) <i>arizona beige</i></p>
<p>verde comodoro (opz. 0750) <i>comodoro green</i></p>	<p>rosso jaipur (opz. 0751) <i>jaipur red</i></p>
<p>grigio efeso (opz. 0721) <i>efeso gray</i></p>	

# FINITURE MELAMINICO

MELAMINE FINISHES

## CREO KYRA VINTAGE

### MELAMINICO

MELAMINE

<p>abete nordico bianco (opz. 4406) <i>white nordic fir</i></p>	<p>abete nordico terra (opz. 4407) <i>earth nordic fir</i></p>
<p>rovere naturale vintage (opz. 5310) <i>vintage natural oak</i></p>	

## CREO MYA

### MELAMINICO

MELAMINE

<p>larice sabbia (opz. 2304) <i>sand larch</i></p>
--



STRUTTURA METALLO



METALLO



VETRO

SERIGRAFATO

# PIN VETRO SERIGRAFATO

TAVOLO / TABLE

TAVOLO "PIN" ALLUNGABILE CON PROLUNGHE IN MELAMINICO  
STRUTTURA E GAMBE A SPILLO METALLO VERNICIATO  
PIANO SP. 0,8 VETRO SERIGRAFATO COLORI LAMINAM

"PIN" EXTENDIBLE TABLE WITH MELAMINE  
PAINTED METAL FRAME AND POINTED LEGS  
TH. TOP 0.8 SILK-SCREEN PRINTED GLASS LAMINAM COLORS

**130 X 90 H 78 N.2 PROLUNGHE DA 50**

130 X 90 H 78 N.2 EXTENSIONS CM 50

**160 X 90 H 78 N.2 PROLUNGHE DA 50**

160 X 90 H 78 N.2 EXTENSIONS CM 50

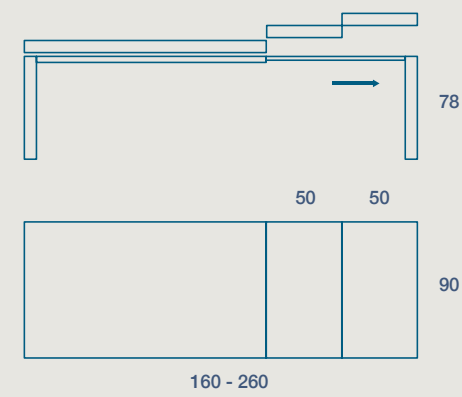
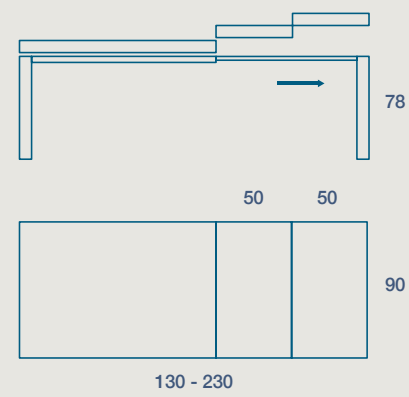

PIN VETRO SERIGRAFATO



SEDIA JOE  
JOE CHAIR

STRUTTURA METALLO



METALLO



VETRO SERIGRAFATO

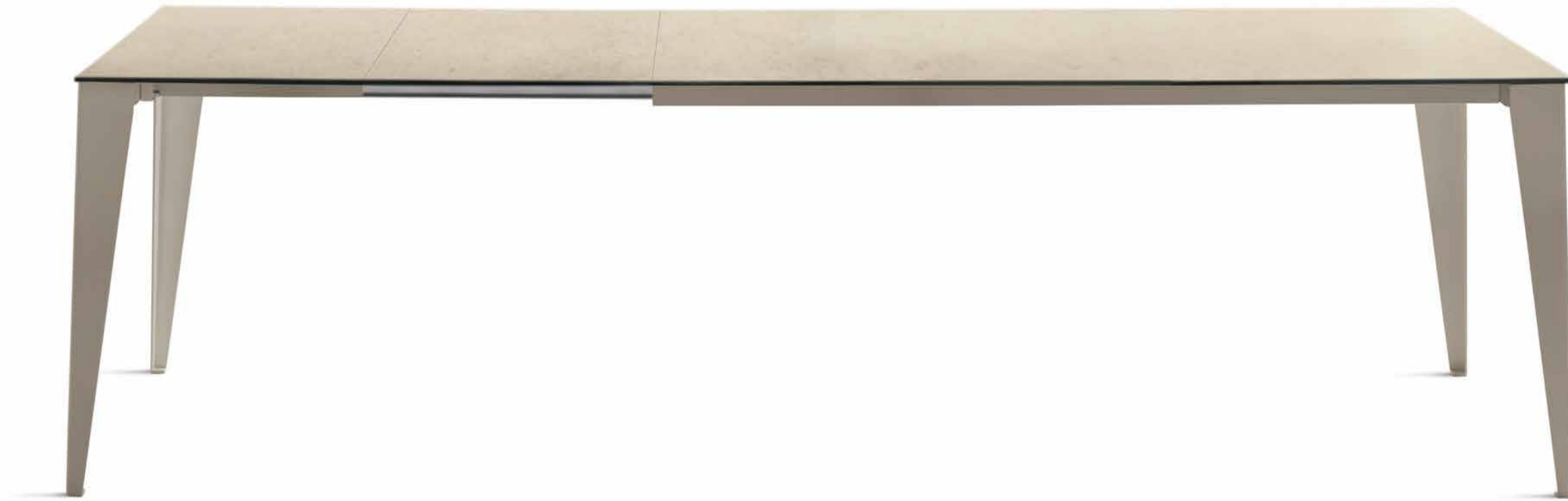

PIN VETRO SERIGRAFATO



### ABBINAMENTI STRUTTURA METALLO VERNICIATO OPACO CON PIANO IN VETRO SERIGRAFATO

MATCHES BETWEEN FRAME AND SILK-SCREEN PRINTED GLASS TOP

piano top		avorio finitura blend <i>ivory blend finish</i>		terra finitura fokos <i>terra fokos finish</i>
struttura structure		castoro <i>beaver</i> opz.AC		castoro <i>beaver</i> opz.TC
piano top		nero finitura blend <i>black blend finish</i>		pietra di savoia finitura cava <i>savoy stone quarry finish</i>
struttura structure		bistro <i>bistro</i> opz.NB		argilla <i>clay</i> opz.PA
piano top		sale finitura fokos <i>salt fokos finish</i>		
struttura structure		fumo <i>smoke</i> opz.SF		

CODICE / CODE	DESCRIZIONE / DESCRIPTION
08PI13V	130 x 90 Allungabile 230 H 78 / 130 x 90 Extendable 230 H 78
08PI16V	160 x 90 Allungabile 260 H 78 / 160 x 90 Extendable 260 H 78